

PRODUCT CATALOG

KEOFITT CLASSIC



KEOFITT
WORLD LEADERS IN STERILE SAMPLING™

KEOFITT CLASSIC

Coaxial steam sterilizable design with separate inlet for SIP and CIP: The reference for hygienic and microbiological sampling for four decades, this is the original, in-situ sterilizable sampling valve that continues to revolutionize the field of sterile sampling.

Refined over the years - inside electro-polish being the latest addition - it remains the most popular and best selling valve in the market by far. It is based on Keofitt's unique, patented membrane and is used in more than 300,000 sampling points worldwide.

Available in several models/sizes:

- W9 (ID 9 MM)
- "INGOLD" (ID 9 MM)
- M4 (ID 4 MM)
- 4KAI (ID 5 MM)
- W15 (ID 15MM)
- W25 (ID 25MM)



HOW IT WORKS

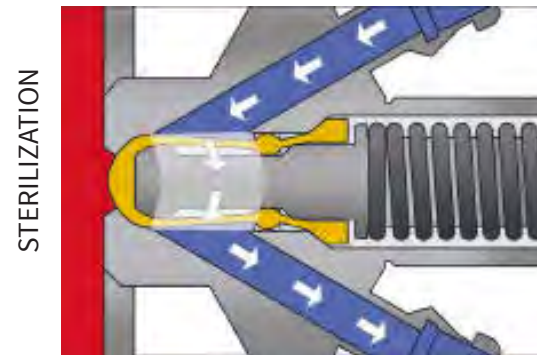
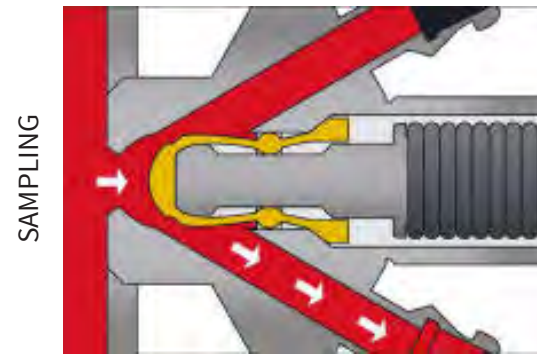

KEOFITT CLASSIC W9 SAMPLING VALVE

The KEOFITT CLASSIC W9 Sampling Valve is considered the father of all steam-sterilizable sampling valves. Refined through 40 years of experience it remains KEOFITT's most popular sampling valve. Designed for the sampling of medium viscosity products in the range of 0-1000 cP with particles less than 3 mm in diameter, it covers most needs for liquid sampling. Sampling of more viscous liquids is possible, only will it take longer (depending on process pressure).

This valve is used in a range of industries such as brewery, dairy, pharmaceutical and bio-tech for products such as:











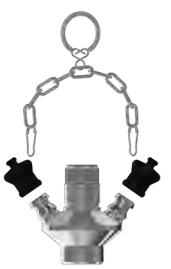

- Medical solutions
- Filtered Beer
- Creams and lotions
- Unprocessed milk

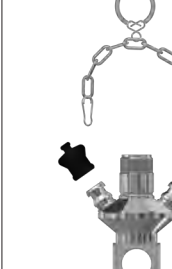
Besides the selection of the Valve Body and the Valve Head there are three different membrane materials to choose from: Silicone, EPDM and PTFE.

Accessories include quick couplings for the connection of tubing, piping and more.









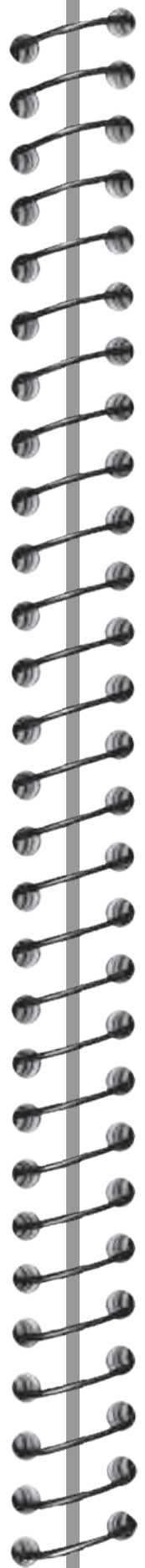

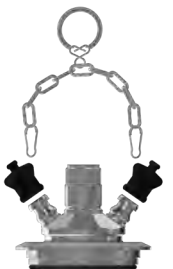

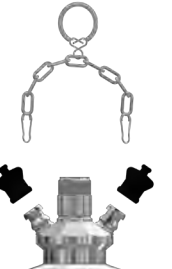

KEOFITT CLASSIC W9 SAMPLING VALVE - BODIES

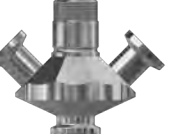











	WELDING BODIES				
	TANK WELDING	PIPE WELDING 1"	PIPE WELDING NW25	IN-LINE VERTICAL	IN-LINE HORIZONTAL
HOSE PIECE	 850001	 850011	 850014	 850027*	 850028*
1/2" TRI-CLAMP	 850006	 850010	<i>On request</i>	<i>On request</i>	<i>On request</i>
THREAD M16X1,5	 850015	 850016	 850018	<i>On request</i>	<i>On request</i>
1/2" WELDING ENDS	 850007	 850019	<i>On request</i>	<i>On request</i>	<i>On request</i>

* ON REQUEST ONLY!













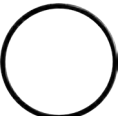
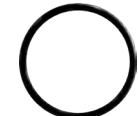



















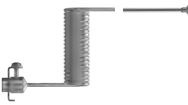















CONNECTION BODIES						
VARIVENT Ø50	VARIVENT Ø68	MINI CLAMP	CLAMP 1" & 1½"	CLAMP 2"	CLAMP 3"	THREAD M28X1,5
 850008	 850009	 850036	 850021	 850003	 850004	 M28X1,5 850031 DIN 11851 DN 10 850040
 850020	 850013	 850039	 850022  850025	 850005  850026	<i>On request</i>	
<i>On request</i>	<i>On request</i>	<i>On request</i>	 850024	<i>On request</i>	<i>On request</i>	 850037 M28X1,5
<i>On request</i>	<i>On request</i>	<i>On request</i>	<i>On request</i>	<i>On request</i>	<i>On request</i>	

KEOFITT CLASSIC W9 SAMPLING VALVE - HEADS









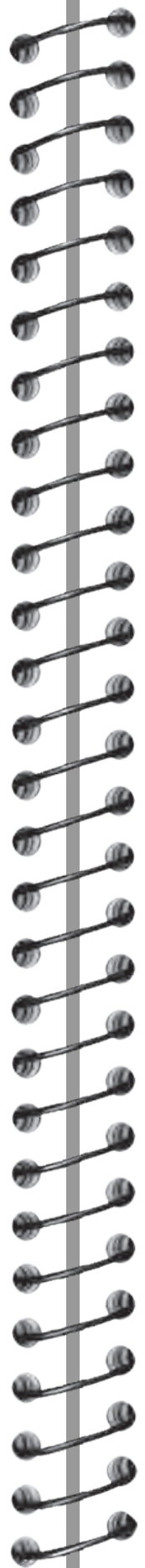



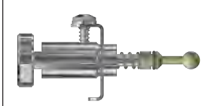









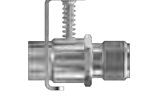

		TYPE H TURN KNOB 0-10 BAR (FFKM 0-6 BAR)	TYPE H TURN KNOB W/. MICROPORT 0-10 BAR	TYPE K KEY RING 0-10 BAR (FFKM 0-6 BAR)	TYPE K KEY RING W/OPT. MICROPORT 0-10 BAR
		W9 HEADS			
W9 HEADS	SILICONE	 600041	 600048	 600042	 600049
	EPDM	 600041E	 600048E	 600042E	 600049E
	FFKM	 600041F	<i>Not available</i>	 600042F	<i>Not available</i>
	PTFE	 855541	<i>Not available</i>	 855542	<i>Not available</i>

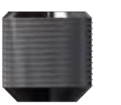
TYPE Q LEVER HANDLE 0-10 BAR (FFKM 0-6 BAR)	TYPE N PNEUMATIC 0-10 BAR (FFKM 0-6 BAR)	TYPE N PNEUMATIC, ADJUSTABLE 0-10 BAR (FFKM 0-6 BAR)	TYPE B NO SPRING 0-12 BAR(G)
 600043	 600044	 600045	 600047
 600043E	 600044E	 600045E	 600047E
 600043F	 600044F	 600045F	 600047F
 855543	 855544	 855545	 855547

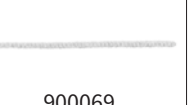
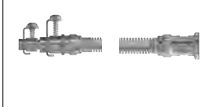
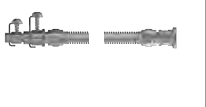
KEOFITT CLASSIC W9 - PARTS & ACCESSORIES

W9™ PARTS & ACCESSORIES	O-RINGS	 400208 EPDM 60X3	 400308 EPDM 42X3	 550184 FESTO	 600825 SILICONE 7.1X1.6	 600825E EPDM 7.1X1.6	 800830 10.3X2.4 SILIC
	MEMBRANES	 600051 SILICONE	 600052 EPDM	 600251 SILICONE MP	 600252 EPDM MP	 600053 FFKM	 850055 PTFE
	FOR THREAD M16X1,5	 700061 STEEL CAP	 700070 TUBE FITTING WL	 700071 TUBE FITTING PTFE	 700084 BARB 4MM	 700085 BARB 6MM	 700062 HP W9 16X1.5
	FOR HOSE PIECE	 550057 KÄRCHER ADAPTOR	 600062 RUBBER CAP	 800013 QC SPIKE	 800058 COIL	 800059 XL COIL	 800070 QC STEEL PIPE
	FOR MINI TRI-CLAMP	 300021 CLAMP PTFE 10/8	 550004 PTFE TC 0.5M	 550005 PTFE TC 1.0M	 800014 ADAPTER TC/1"	 900013 MINI CLAMP SPIKE	 900096 ADAPTOR W9/W15 HP/TC
	FOR VALVE HEADS	 600076 KEY RING	 600149 BUSHING	 600170 LEVER HANDLE Q/N	 600255 TOOL PTFE	 600370 LEVER HANDLE SELF-CLOSING	 900018 TOMMY BAR
	MISC.	 600064 DOUBLE ST. ST. CHAIN	 600066 SINGLE ST. ST. CHAIN	 900022 NEEDLE	 400166 PROXIMITY SENSOR	 600266 PROXIMITY SENSOR	 600267 PROXIMITMOUNTING KIT
	 900047 TUBE PTFE 10/8	 900186 CLAMP RING 2"	 900075 CLAMP RING 1/2"	 900086 CLAMP RING 1"	 900021 BLIND CAP	 900076 BLIND CAP 1"	



 800830E EPDM 10.3X2.4	 800859 SILICONE 7.5X2.5	 900829 EPDM 21X4				
 800077 EMERGENCY TOOL						
 800061 QC PLUG	 800082 QC HOSE BARB 3/8	 800083 QC TC	 800086 QC W9 WITH M4 HP	 900045 QC SYRINGE INJECTION	 550003 PTFE QC 1.0M	 550002 PTFE QC 0.5M
 900097 ADAPTER M4 HP/TC				 800091 QC PTFE	 800171 QC PTFE M16X1.5	 900031 HP MALE THREAD M12
 700108 HOSE PIECE	 800052 HOSE PIECE/ HOSE PIECE	 800075 WELDING PIECE FOR PTFE	 850840 PINOL SCREW	 900008 SOCKET ALU-TANKS	 900069 WICK FOR W9 VALVE MP	
 550002.2 PTFE QC/TC 0.5M	 550003.2 PTFE QC/TC 1.0M	 900092 GASKET EPDM 2"	 900093 GASKET EPDM 3"	 900074 GASKET EPDM 3/4"	 900087 GASKET 1/2"	 900091 GASKET EPDM 1"

HOW IT WORKS

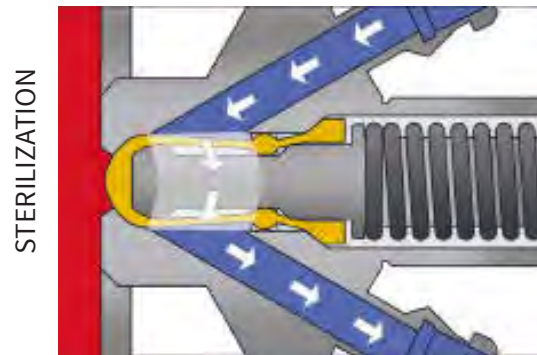
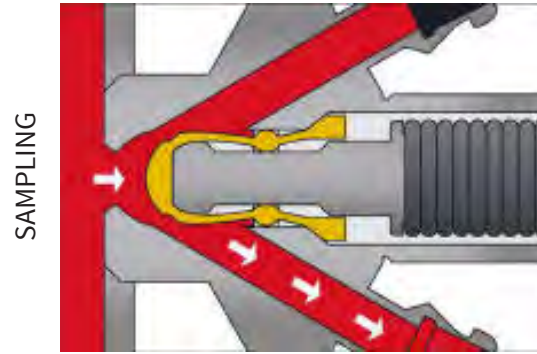

KEOFITT CLASSIC "INGOLD" SAMPLING VALVE

The KEOFITT CLASSIC "INGOLD" sampling valve is designed to fit bio-connectors type Ingold®. Designed for the sampling of medium viscosity products in the range of 0-1000 cP with particles less than 2 mm in diameter, it covers most needs for liquid sampling. Sampling of more viscous liquids is possible, only will it take longer (depending on process pressure).

This valve is used in a range of industries such as brewery, dairy, pharmaceutical and bio-tech for products such as:



- Medical solutions
- Filtered Beer
- Creams and lotions
- Unprocessed milk

Besides the selection of the Valve Body and the Valve Head there are three different membrane materials to choose from: Silicone, EPDM and PTFE.



Accessories include quick couplings for the connection of tubing, piping and more.



KEOFITT CLASSIC "INGOLD" SAMPLING VALVE - BODIES

		STANDARD FOR 40 MM PORT LENGTH*	
INGOLD BODIES	HOSE PIECE	<i>On request</i>	<i>On request</i>
	MINI TRI-CLAMP	 <p>310002</p>	 <p>310005</p>
	WELDING LINER	<i>On request</i>	<i>On request</i>

* OTHER PORT LENGTH - AVAILABLE ON REQUEST





		STANDARD FOR 52 MM PORT LENGTH*	
INGOLD BODIES	HOSE PIECE	<i>On request</i>	<i>On request</i>
	MINI TRI-CLAMP	 <p>320002</p>	 <p>320005</p>
	WELDING LINER	<i>On request</i>	 <p>320007</p>

* OTHER PORT LENGTH - AVAILABLE ON REQUEST

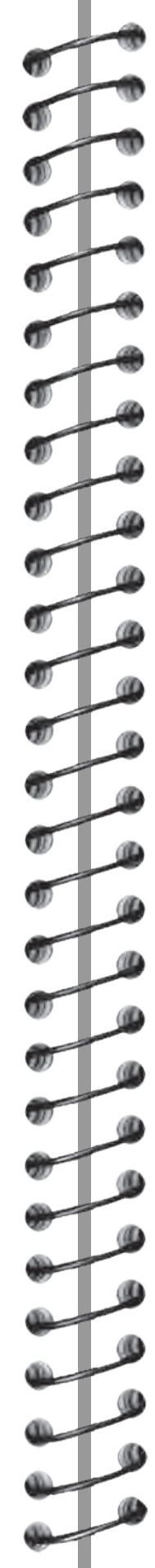
KEOFITT CLASSIC "INGOLD" SAMPLING VALVE - HEADS



		TYPE H TURN KNOB 0-10 BAR(G)		TYPE Q LEVER HANDLE 0-10 BAR(G)	
INGOLD HEADS	SILICONE	 310041	 320041	 310043	 320043
	EPDM	 310041E	 320041E	 310043E	 320043E
	PTFE	 315541	 325541	 315543	 325543

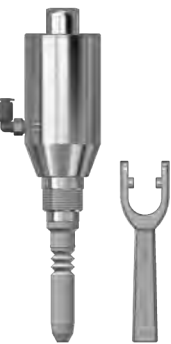

		TYPE N LEVER HANDLE PNEUMATIC 0-10 BAR(G)		TYPE N PNEUMATIC, ADJUSTABLE 0-10 BAR	
		 310044	 320044	<i>On request</i>	
		 310044E	 320044E	<i>On request</i>	
		 315544	 325544	<i>On request</i>	

KEOFITT CLASSIC "INGOLD" - PARTS & ACCESSORIES

W9™ INGOLD PARTS & ACCESSORIES

	O-RINGS	MEMBRANES	FOR MINI TRI-CLAMP	FOR VALVE HEADS	MISC.								
	 <p>300118 EPDM 20.24X2.62</p>	 <p>300119 20.24X2.62 FDA</p>	 <p>550184 FESTO</p>										
		 <p>310051 SILICONE (I40)</p>	 <p>310052 EPDM (I40)</p>	 <p>310055 PTFE (I40)</p>	 <p>320051 SILICONE (I52)</p>	 <p>320052 EPDM (I52)</p>	 <p>320055 PTFE (I52)</p>						
			 <p>300021 CLAMP PTFE 10/8</p>	 <p>550004 PTFE TC 0.5M</p>	 <p>550005 PTFE TC 1.0M</p>	 <p>800014 ADAPTER MINI CLAMP /1" CLAMP</p>	 <p>800083 QC TC</p>	 <p>900013 MINI CLAMP SPIKE</p>	 <p>900096 ADAPTER HP/TC</p>	 <p>900097 ADAPTOR M4 HP/TC</p>			
			 <p>300255 TOOL PTFE (I40/I52)</p>	 <p>600149 BUSHING</p>	 <p>600170 LEVER HANDLE Q/N</p>	 <p>600370 LEVER HANDLE SELF-CLOSING</p>	 <p>900074 GASKET EPDM 3/4"</p>	 <p>900087 GASKET EPDM 1/2"</p>	 <p>550002.2 PTFE TUBING W/QC/TC 0.5M</p>	 <p>550003.2 PTFE TUBING W/QC/TC 1 M</p>	 <p>900018 TOMMY BAR</p>	 <p>850840 PINOL SCREW F/W9 HEAD</p>	
					 <p>320530 ADAPTOR 30MM (I52)</p>	 <p>320540 ADAPTOR 40 MM (I52)</p>	 <p>320830 ADAPTOR PTFE 50MM (I52)</p>	 <p>900075 CLAMP RING 1/2"</p>	 <p>900021 BLIND CAP FOR MINI CLAMP</p>	 <p>700108 HOSE PIECE W9</p>	 <p>400166 PROXIMITY SWITCH FOR M4/W9</p>	 <p>600266 PROXIMITY SENSOR W9 - CLOSED POS.</p>	 <p>600267 PROXIMITY SENSOR MOUNTING KIT W9</p>

HOW IT WORKS

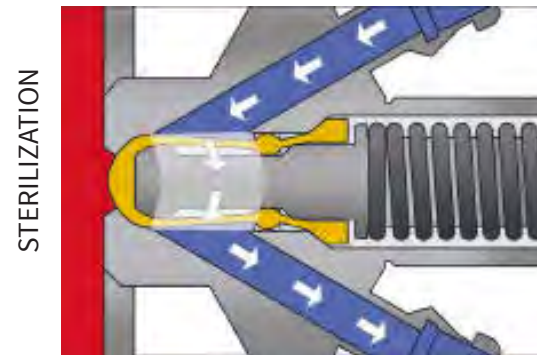
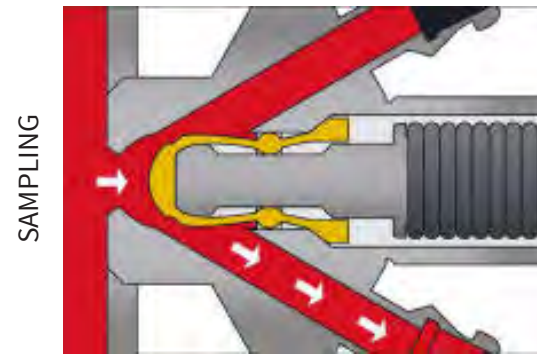

KEOFITT CLASSIC 4KAI SAMPLING VALVE

The KEOFITT CLASSIC 4KAI Sampling Valve is the smallest KEOFITT CLASSIC valve available. It is designed for the sampling of low viscosity products in the range of 0-100 cP with particles less than 1.5 mm in diameter. Sampling of more viscous liquids is possible, only will it take longer (depending on process pressure).

This valve is used in a range of industries such as brewery, dairy, pharmaceutical and bio-tech for products such as:



- Water
- Milk
- Medical solutions
- Filtered Beer
- Perfume
- Olive Oil



Besides the selection of the Valve Body and the Valve Head there are three different membrane materials to choose from: Silicone, EPDM and PTFE.

Accessories include quick couplings for the connection of tubing, piping and more.

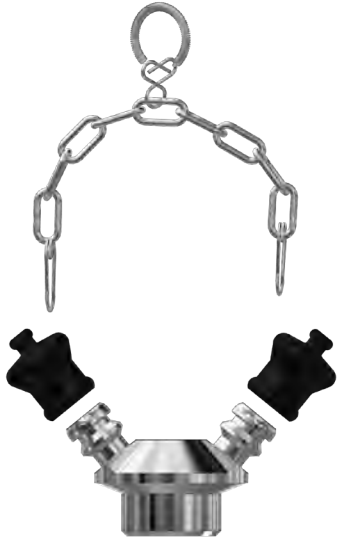

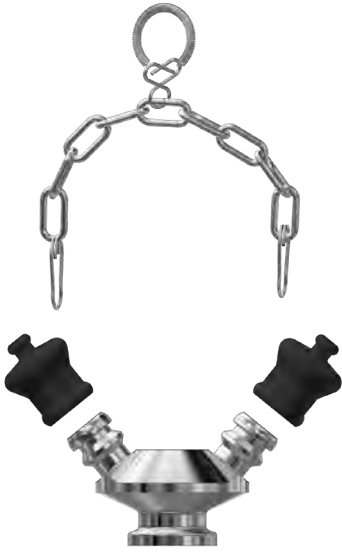

KEOFITT CLASSIC 4KAI SAMPLING VALVE - BODIES

		WELDING BODIES		
		TANK WELDING Ø28	PIPE WELDING 1"	PIPE WELDING NW25
4KAI BODIES	HOSE PIECE			
		440001	440011	440014



















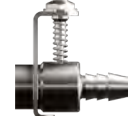





		CONNECTION BODIES	
		MINI CLAMP	CLAMP 1" & 1½"
			
		440021	440022









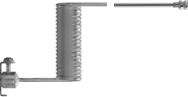

KEOFITT CLASSIC 4KAI SAMPLING VALVE - HEADS

4KAI HEADS	TYPE H TURN KNOB 0-10 BAR (G)
	 <p>440041</p>
	 <p>440041E</p>
PTFE	 <p>445541</p>

TYPE N PNEUMATIC 0-10 BAR (G)
 <p>440044</p>
 <p>440044E</p>
 <p>445544</p>

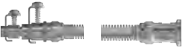
KEOFITT CLASSIC 4KAI - PARTS & ACCESSORIES

4KAI™ PARTS & ACCESSORIES	O-RINGS	 800830 10.3X2.4 SILIC	 800830E EPDM 10.3X2.4	 550184 FESTO	 600825 SILICONE 7.1X1.6			
	MEMBRANES	 400051 SILICONE	 400052 EPDM	 400055 PTFE				
	FOR HOSE PIECE	 550057 KÄRCHER ADAPTOR	 800082 QC HOSE BARB 3/8	 800083 QC TC	 800086 QC W9 WITH M4 HP	 800061 QC PLUG	 800070 QC STEEL PIPE	
		 600062 RUBBER CAP						
	FOR VALVE HEADS	 900018 TOMMY BAR	 600370 LEVER HANDLE SELF-CLOSING	 600170 LEVER HANDLE Q/N	 400255 TOOL PTFE			
MISC.	 440064 DOUBLE ST. ST. CHAIN	 900086 CLAMP RING 1"	 900075 CLAMP RING 1/2"	 900047 TUBE PTFE 10/8	 900087 GASKET 1/2"	 900091 GASKET EPDM 1"		

 900045 QC SYRINGE INJECTION	 900031 HP MALE THREAD M12	 800058 COIL	 800059 XL COIL	 800091 QC PTFE	 550003 PTFE QC 1.0M	 550002 PTFE QC 0.5M	
 550002.2 PTFE QC/TC 0.5M	 550003.2 PTFE QC/TC 1.0M	 440149 BUSHING FOR 4KAI/ BASIX HEAD	 800052 HOSE PIECE/ HOSE PIECE				

HOW IT WORKS

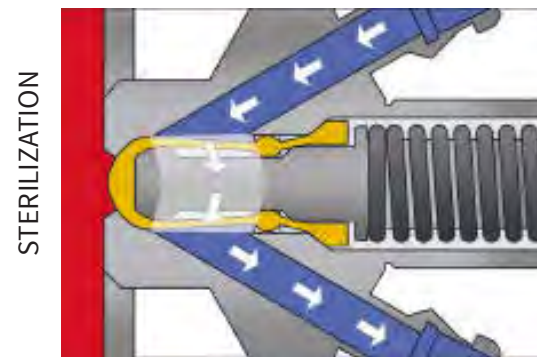
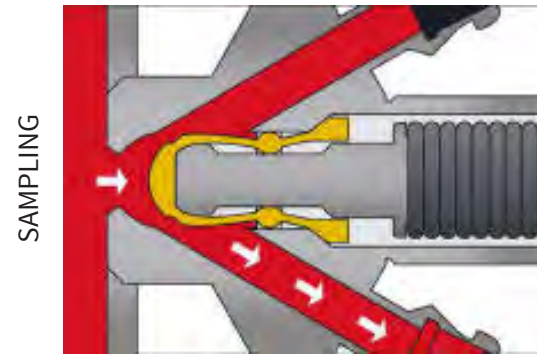

KEOFITT CLASSIC W15 SAMPLING VALVE

The KEOFITT CLASSIC W15 Sampling Valve is designed for high viscosity products in the range of 0-50,000 cP with particles up to 8 mm in diameter. Sampling of more viscous liquids is possible, only will it take longer (depending on process pressure).



This valve is used in a range of industries such as brewery, dairy, pharmaceutical and bio-tech for products such as:

- Yoghurt
- Honey
- Syrup
- Ketchup
- Marmalade
- Creams and lotions
- Fruit pulp products

Available with PTFE membrane.



KEOFITT CLASSIC W15 SAMPLING VALVE - BODIES

		WELDING BODIES	
		TANK WELDING	PIPE WELDING
W15 BODIES	3/4" TRI-CLAMP	 <p>860001</p>	 <p>860011</p>
	3/4" WELDING ENDS	 <p>860007</p>	<p><i>On request</i></p>

CONNECTION BODIES			
VARIVENT Ø68	CLAMP 1"	CLAMP 2"	CLAMP 3"
 <p>860009</p>	 <p>860004*</p>	 <p>860002</p>	 <p>860003</p>
<p><i>On request</i></p>	<p><i>On request</i></p>	<p><i>On request</i></p>	

* ON REQUEST ONLY!

KEOFITT CLASSIC W15 SAMPLING VALVE - HEADS





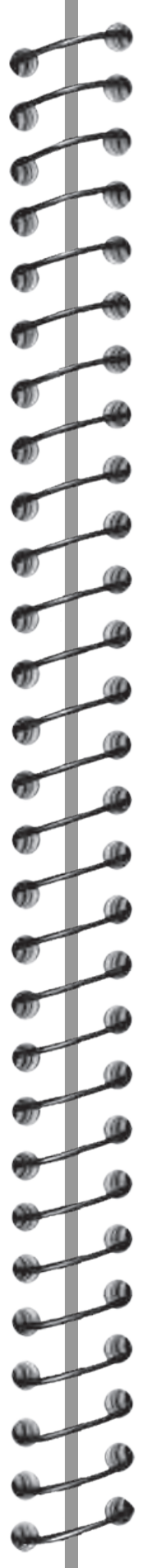



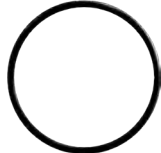

W15 HEADS	<p>TYPE H TURN KNOB 0-10 BAR (G)</p>	<p>TYPE B NO SPRING 0-12 BAR (G)</p>
	 <p>865541</p>	 <p>865547</p>

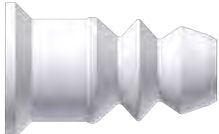
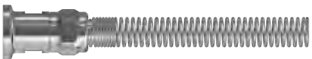





PTFE



<p>TYPE N PNEUMATIC 0-10 BAR (G)</p>
 <p>865544</p>

KEOFITT CLASSIC W15 - PARTS & ACCESSORIES

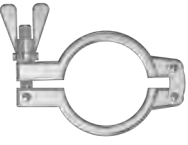
W15™ PARTS & ACCESSORIES	O-RINGS	 400208 EPDM 60X3	 550184 FESTO	
	MEMBRANES	 860055 PTFE		
	FOR MINI TRI-CLAMP	 300021 CLAMP PTFE 10/8	 550004 PTFE TC 0.5M	 550005 PTFE TC 1.0M
	FOR VALVE HEADS	 600170 LEVER HANDLE Q/N	 600370 LEVER HANDLE SELF-CLOSING	 860255 TOOL PTFE
	MISC.	 900075 CLAMP RING 1/2"	 900074 GASKET EPDM 3/4"	 900092 GASKET EPDM 2"

 800014 ADAPTER TC/1"	 900013 MINI CLAMP SPIKE	 900096 ADAPTER HP/TC
 900093 GASKET EPDM 3"	 900186 2" CLAMP RING	 900021 BLIND CAP F/MINI TRI CLAMP

HOW IT WORKS

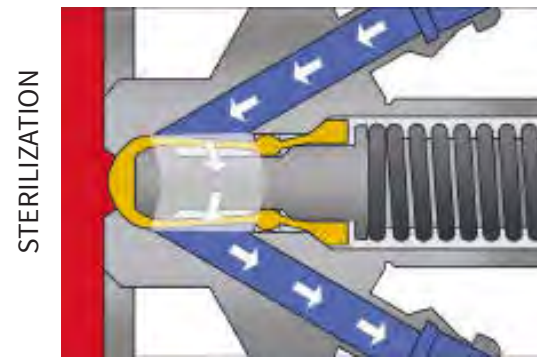
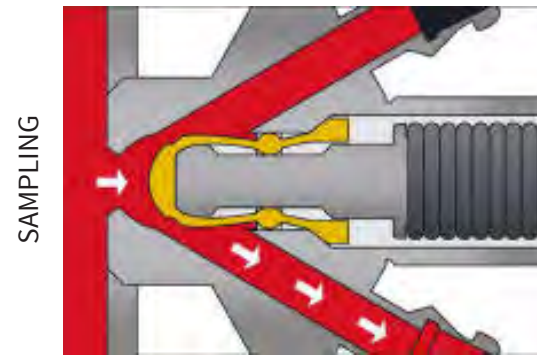

KEOFITT CLASSIC W25 SAMPLING VALVE

The KEOFITT CLASSIC W25 Sampling Valve is the largest KEOFITT sampling valve. Designed for sampling of very high viscosity products in the range of 0-250,000 cP and particles less than 17 mm in diameter. Sampling of more viscous liquids is possible, only will it take longer (depending on process pressure).

This valve is used in a range of industries such as food, dairy, pharmaceutical and bio-tech for products such as:



- Peanut Butter
- Fruit Pulp
- Syrup
- Cellulose
- Fruit Mixed Products
- Cosmetics

Available with PTFE membrane.



KEOFITT CLASSIC W25 SAMPLING VALVE - BODIES

		WELDING BODIES	
		TANK WELDING	PIPE WELDING
W25 BODIES	1" CLAMP	 <p>870001</p>	<p><i>On request</i></p>
	VELDING LINER	<p><i>On request</i></p>	<p><i>On request</i></p>

		CONNECTION BODIES	
		VARIVENT Ø68	CLAMP 3"
		 <p>870009</p>	 <p>870003</p>
		<p><i>On request</i></p>	<p><i>On request</i></p>

KEOFITT CLASSIC W25 SAMPLING VALVE - HEADS

W25 HEADS

PTFE

TYPE N
LEVER HANDLE
PNEUMATIC









875544

TYPE B
NO SPRING
0-12 BAR

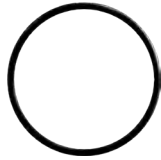

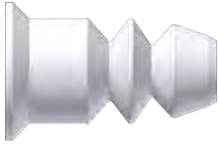
875547

KEOFITT CLASSIC W25 - PARTS & ACCESSORIES

W25™ PARTS & ACCESSORIES	O-RINGS	 400208 EPDM 60X3	 900091 GASKET EPDM 1"	
	MEMBRANES	 870055 PTFE		
	FOR VALVE HEADS	 870255 TOOL PTFE		
	MISC.	 900086 CLAMP RING 1"	 800014 ADAPTER TC/1"	 900093 GASKET EPDM 3"

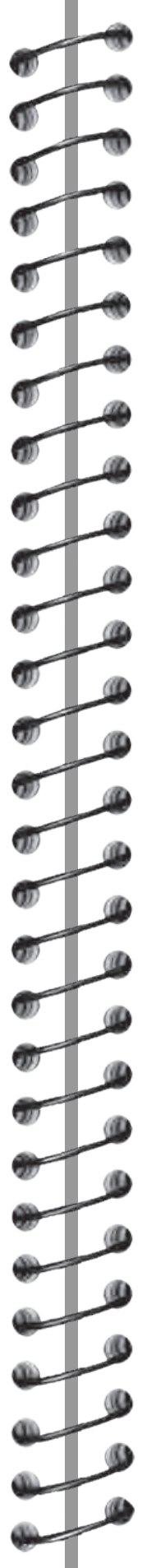

 900187 CLAMP RING FOR W25 VALVE		